

Solid Oak Door Kits Assembly Instructions



BRITISH HARDWOODS
THE OAK SPECIALISTS

Contact Us

Tel: 01535 637755

Fax: 01535 635151

Email: enquiries@britishhardwoods.co.uk

Web: www.britishhardwoods.co.uk



Table of Contents

Farmhouse Oak Door Style	3
Ledged and Braced Oak Door Style	5
Battened Oak Door Style	7
Dovetail Oak Door Style.....	9



Farmhouse Oak Door Style

- 1) Put the T&G Boards together. Cut the ledges to about 32mm less than the finished width of the door.
- 2) Mark the position of the ledges;

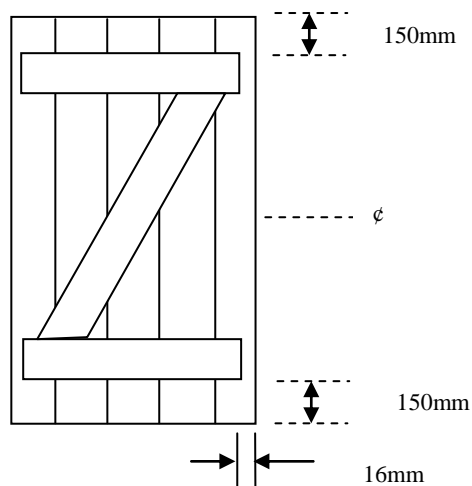

- 3) Dismantle, leaving just 1 board. Pre drill and pin through face of board into ledges making sure they are square

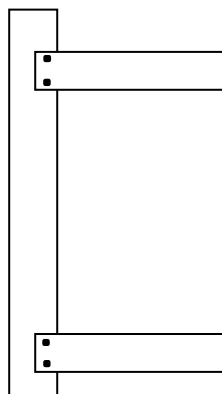

- 4) Secret nail the first board and subsequent boards into the ledges. The last board will need to be face pinned.



- 5) Cut the two braces at the correct angle to give an exact fit. Either pin into place or drill and plug;

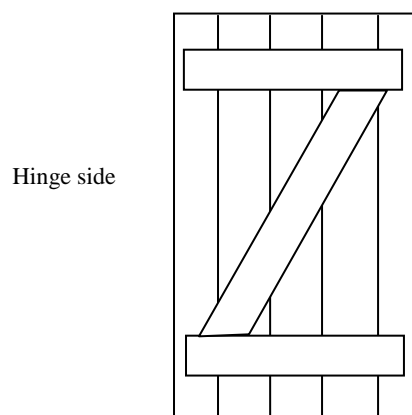

- 6) Mark out and drill through into the ledges

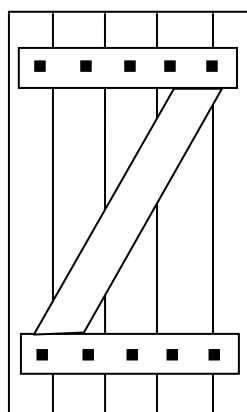

- 7) Put a little PVA glue in the hole and tap in a peg. When dry cut the peg to about 4mm proud of the ledge.

- 8) Using a chisel, with bevelled edge down, edge off the pegs;

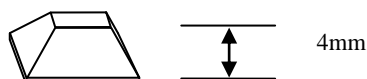

- 9) Fit hardware and finish with hardwax oil.



Ledged and Braced Oak Door Style

There are a number of ways that these can be constructed including a full brace that is half jointed into the ledges, two braces making a double Z pattern or with two braces making a single Z shape.



Double Z pattern



Single Z pattern

- 1) Put the T&G Boards together. Cut the ledges to about 32mm less than the finished width of the door.
- 2) Mark the position of the ledges;

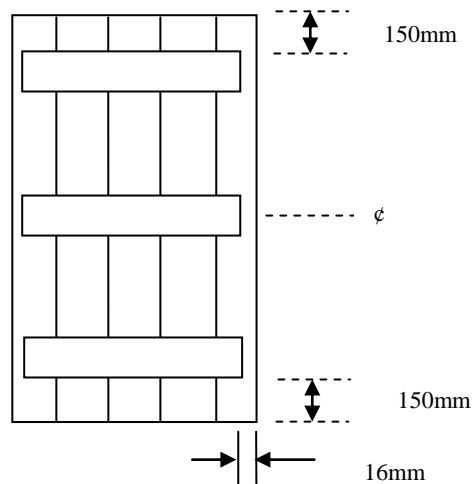

- 3) Dismantle, leaving just 1 board. Pre drill and pin through face of board into ledges making sure they are square

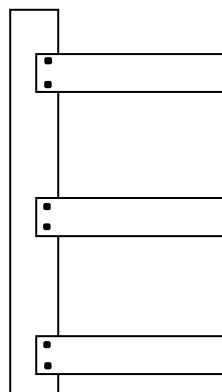

- 4) Secret nail the first board and subsequent boards into the ledges. The last board will need to be face pinned.



- 5) Cut the two braces at the correct angle to give an exact fit. Either pin into place or drill and plug;

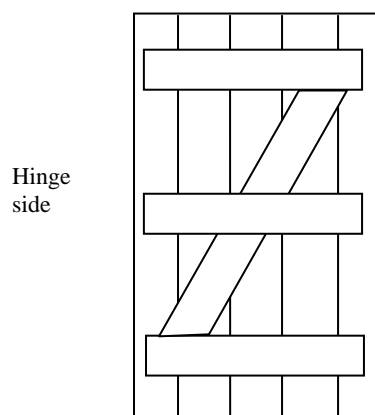

- 6) On the face side mark out and drill through the T&G Boards into the ledges

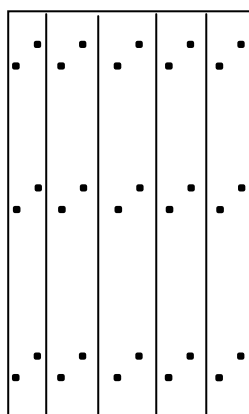

- 7) Put a little PVA glue in the hole and tap in a peg. When dry cut the peg to about 4mm proud of the face of the door.
- 8) Using a chisel, with bevelled edge down, edge off the pegs;

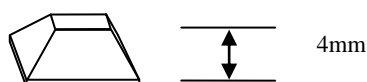

- 9) Fit hardware and finish with hardwax oil.



Battened Oak Door Style

- 1) Assemble boards
- 2) Cut battens to about 15 – 20mm narrower than finished door width.
- 3) Mark out the position of the battens on the back of the door.

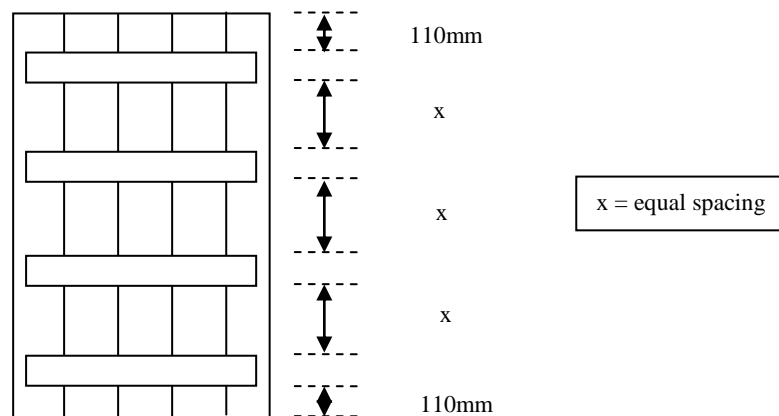

- 4) Clamp the panels together and stick the battens in place with double sided tape to aid handling.
- 5) Make a template for the nail holes to the same size as the top of the batten.

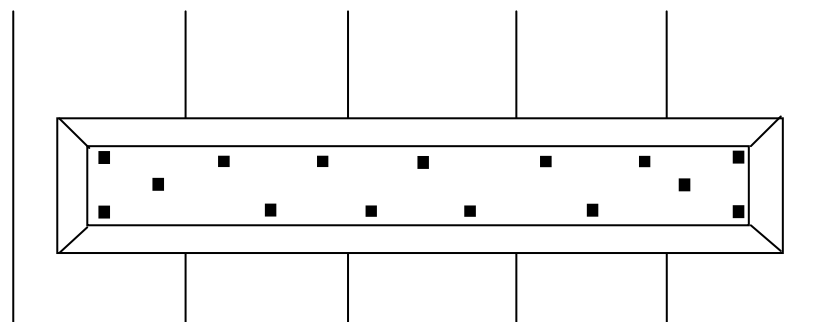

- 6) Mark out the nail holes on the first batten then turn pattern upside down on second batten and so on.
- 7) Drill through battens and panels with a block to avoid breakout.



- 8) Nail through the face with the nails aligned vertically.

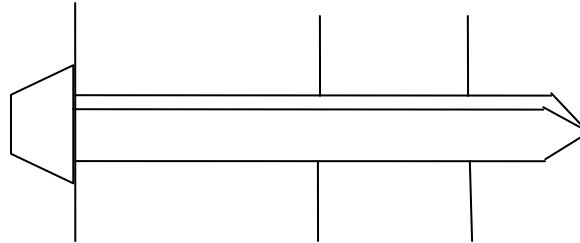

- 9) Carefully tap over the end of the nail so it bends horizontally.
- 10) Trim door to size.
- 11) Fit hardware and finish with hardwax oil



Dovetail Oak Door Style

- 1) Assemble panels
- 2) Mark out position of dovetails and stick to panels.
- 3) The dovetails will be prepared with square holes. Drill a clearance hole through the dovetail and then pre-drill a fine hole into the T&G board.

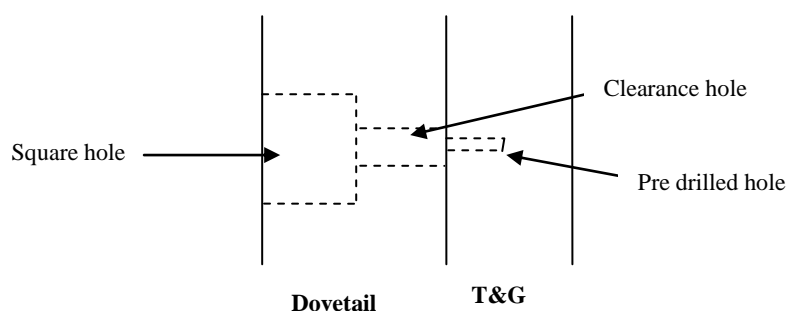

- 4) Screw dovetail to panels.

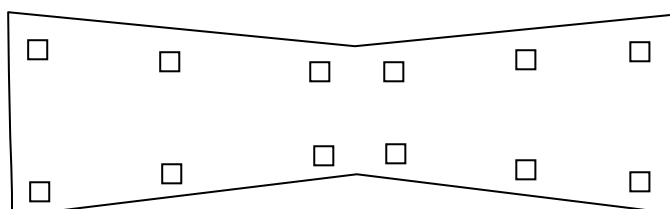

- 5) Finish off the pegs as per battened doors.
- 6) Fit hardware and finish with hardwax oil.